

Article number: 2301072671

Description: E+G Handwheel
VDS.100+I-A10

Measures

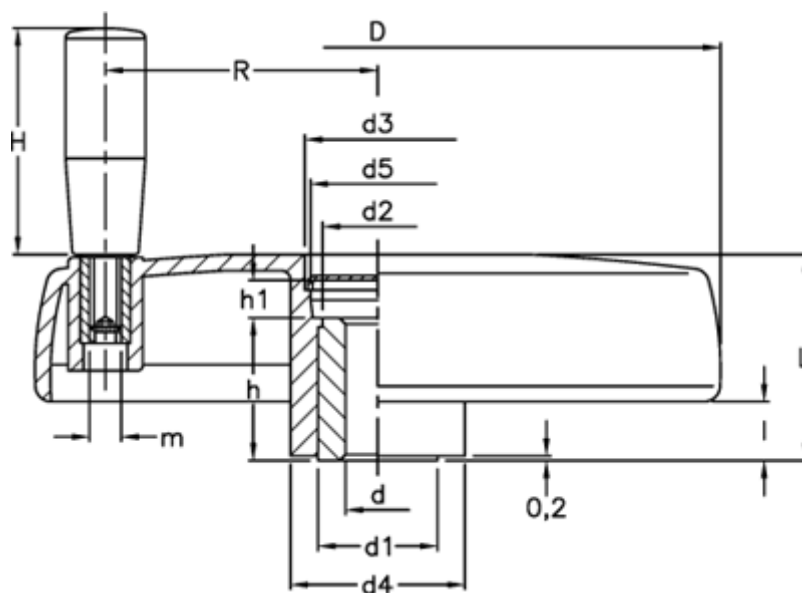

C (N m) = 60	H = 50
D = 102	h = 22
d1 = 22	h1 = 9
d2 = 20.0	l = 10
d3 = 27.0	L = 34
d4 = 30	L (J) = 13
d5 = 25	m = M6
d H7 = 10	R = 39.0